

# Digital Sound Recorder: A case study on designing embedded systems using the UML notation.

**Ivan Porres Paltor**

Åbo Akademi University, Department of Computer Science,  
Lemminkäisenkatu 14, FIN-20520 Turku, Finland  
email: Ivan.Porres@abo.fi

**Johan Lilius**

Åbo Akademi University, Department of Computer Science,  
Lemminkäisenkatu 14, FIN-20520 Turku, Finland  
email: Johan.Lilius@abo.fi

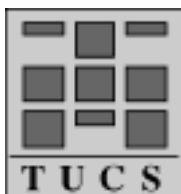

Turku Centre for Computer Science  
TUCS Technical Report No 234  
January 1999  
ISBN 952-12-0367-6  
ISSN 1239-1891

## **Abstract**

This document is an example of the object-oriented analysis and design of an embedded system using the Unified Modelling Language (UML). The analysed system is a digital sound recorder, or Dictaphone. The design has been implemented using an embedded processor and the C++ programming language.

**Keywords:** object-oriented design, UML, embedded systems.

**TUCS Research Group**  
Programming Methodology Research Group

# 1 Introduction

The Unified Modelling Language [BJR1, BJR2], provides a standardised notation to express object-oriented software analysis and design [CY90, MO92, SS95]. UML diagrams are able to model complex software systems including real-time embedded systems.

However, UML is not a software process. UML does not specify the different stages of the development of a software project. The UML standard specifies a notation for several different diagrams, but it does not describe how to create and apply each diagram. [Dou98] presents a methodology for building embedded systems using the UML notation and object-oriented analysis and design techniques.

This document describes the object-oriented design and implementation of a digital sound recorder, or Dictaphone, using the UML notation and the method described by Douglass.

There are several digital sound recorders commercially available in the market. The model described here has been designed following the specifications of a commercial product from a well know manufacturer. These requirements are described in the second section of this document.

The third section discusses the object model of the system and presents the main class diagram. The fourth section continues the object-oriented analysis but focusing in th internal behaviour of each object.

The fifth section deals with the architectural design. We show the hardware architectur of the sound recorder and the concurrency model, where we assign each object to an execution thread.

The design continues defining the collaborations between the different objects. This is done in section number six, where design patterns [GHJV95] are used to glue together the classes defined in the analysis phase. The most specific design issues are discussed in the section number seven.

Finally, The eighth section discusses the implementation. We have implemented th software in the C++ programming language and built the hardware platform to run the code using a 32 bits RISC embedded processor.

## 2 Requirements Analysis

A digital sound recorder is a consumer electronic appliance designed to record and play back speech. The messages are recorded using a built-in microphone and they are stored in a digital memory. The user can quickly play back any message at any moment trough a speaker placed in the front of the device. It should be small, light, easy to use, and battery operated.

Figure 2.1 shows what our sound recorder could look like. It is a hand held unit with flat display and fairly large buttons.

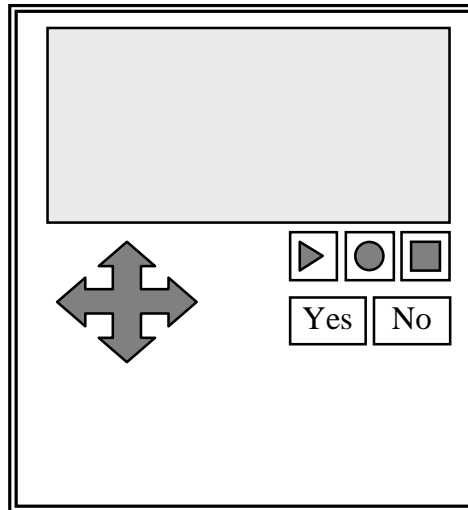

**Figure 2.1: External appearance**

The main features of the product that we are going to consider in our design are:

- Capacity for ten different messages. The length of each message is limited by the available memory.
- Easy to use with on screen menus.
- Direct access to any message.
- Alarm clock with year-2000-ready calendar. The user can set a daily alarm. The alarm beeps until the user presses a key, or after 60 seconds.
- Full Function LCD Display. The current date and time is always shown in the display. The display also shows clear directions about how to use it and what it is doing.
- Battery-level indicator. The system beeps when the battery is low.
- Stand-by mode. It economises the battery power. The system switches off the peripherals when they are not in use. The normal operation is resumed when the user presses a key.
- Good sound quality. Sound is processed at 6Khz using eight bits per sample.

## **2.1 External Events**

An embedded system is constantly interacting with its environment. In this first stage of the analysis, we can consider our system as a black box reacting to the requests and messages from the environment. The environment is composed of several agents. Each agent interacts with our system with a different purpose and it exchanges a different set of messages.

### **Context-Level Diagram**

Figure 2.2 shows all the agents that interact with our system. We have identified three agents: the user, the battery and the time. It also shows the interfaces, sensors and actuators that allow our system and the agents to exchange messages. These messages can be requests from the agents to the system, or responses and services from the system to the agents. The sensors for the messages from the user are the microphone and the buttons. The actuators for the user agent are the speaker and the display. The battery level meter senses the state of the battery.

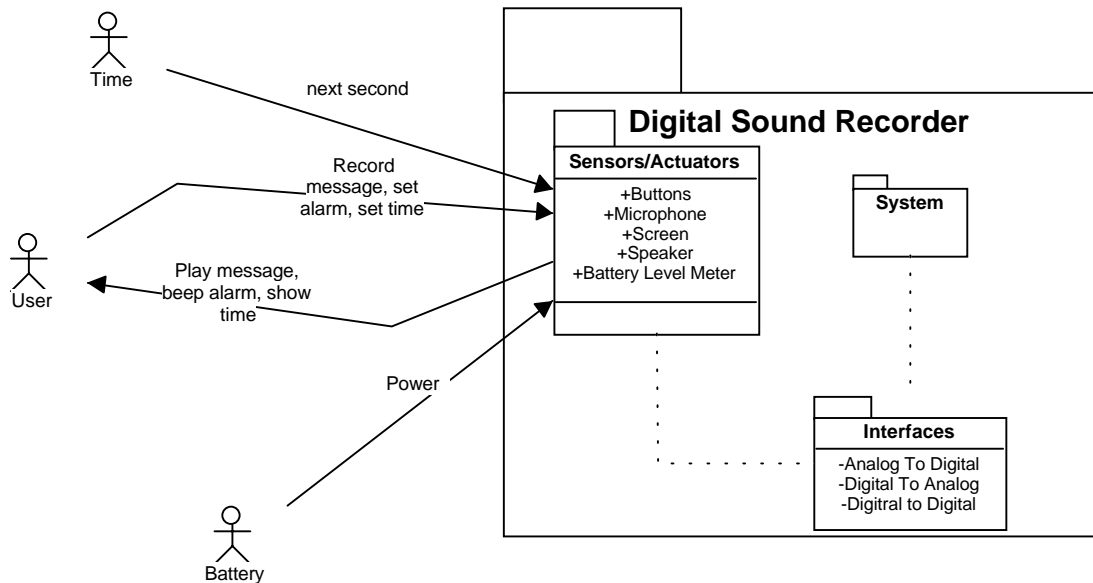

**Figure 2.2: Context-Level diagram**

The Time agent sends a message to our system whenever the time passes. It represents the source of messages like “next second” or “next hour”. In the real implementation, a hardware timer measures the pass of the time.

### Events

An event is an important message from the environment. A real-time reactive system has to react to the external events in a bounded time. The following table shows all the external events that can occur in our system. The direction of an event can be “In”, from the environment to the system, or “Out”, from the system towards the environment. The arrival pattern (A) can be Periodic, if the event occurs on a fixed time basis, or Episodic, if its arrival time is random. The Response time sets an upper bound for the system response actions. The system will behave incorrectly if it does not react within the response time.

	Event	System Response	Direction	A	Resp.
1	A second passes	a. Update internal clock b. Check alarm c. Update clock display, d. Update task progress display.	In	P	0.5 s
2	A sample period passes	a. Play or record next sample	In	P	½ period
3	User presses a command button	a. Show task progress display b. Start recording or playing a message	In	E	0.5 s
4	User presses the “stop” button	a. Current task is stopped b. Update display	In	E	0.5 s
5	Low battery alarm	a. Warn the user and stop current task	In	E	1 s.
6	Enter stand-by mode	a. Switch off the display	In	E	1 s.
7	Wake up, user presses a button while in stand-by mode.	a. Leave stand-by mode, power up display, etc.	In	E	1 s.

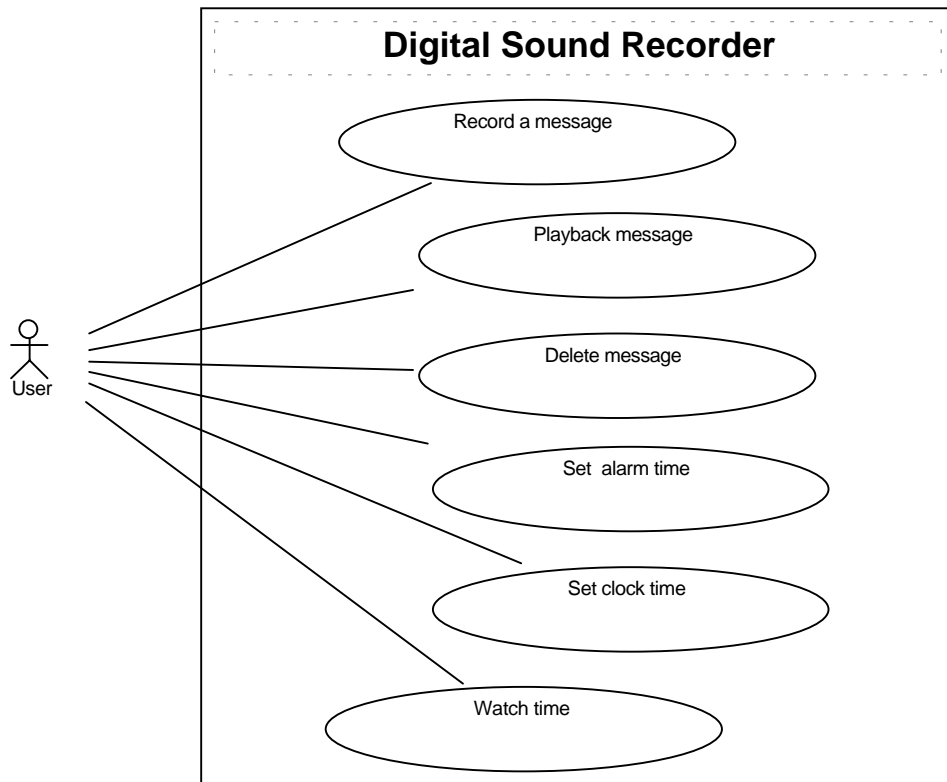

**Figure 2.3: Use Case diagram**

## 2.2 Use Cases

Use cases describe the functionality of the system from the user's point of view. The user may be a person or another machine. Each use case is a different way to use the system and the completion of each use case produces a different result. In our system there are six different use cases, represented in the Figure 2.3.

### **Record a message**

The user selects a message slot from the message directory and presses the 'record' button. If the message slot already stores a message, it is deleted. The system starts recording the sound from the microphone until the user presses the 'stop' button, or the memory is exhausted.

### **Playback a message**

The user selects a recorded message slot and then presses the 'play' button. If the message slot contains a recorded message then it is played through the speaker until its end or until the user presses the stop button.

### **Delete a message**

The user selects a used message slot and then presses the 'delete' button. The message is permanently deleted from the memory and its memory space is recycled.

### **Set the alarm time**

The user can switch on and off the alarm and set the time when the alarm will sound. This is done by selecting the different options of the alarm menu.

### Set the clock time

The user can set the clock time and adjust it to the current time zone.

### Watch the time

The system constantly shows the current time and date on the display. The user just looks at it.

## 2.3 Scenarios

The scenarios should describe the interaction between the active external actors (the user, the battery and the time) with the system. Even if the role of each actor is usually clear, it can be difficult to study all the possible interactions between all the actors and the system. E.g., we have to study what happens when the battery goes low while the system is playing a message, or what to do if the alarm sounds while the system is recording a message. Figure 2.4 shows an scenario for the Play Message use case.

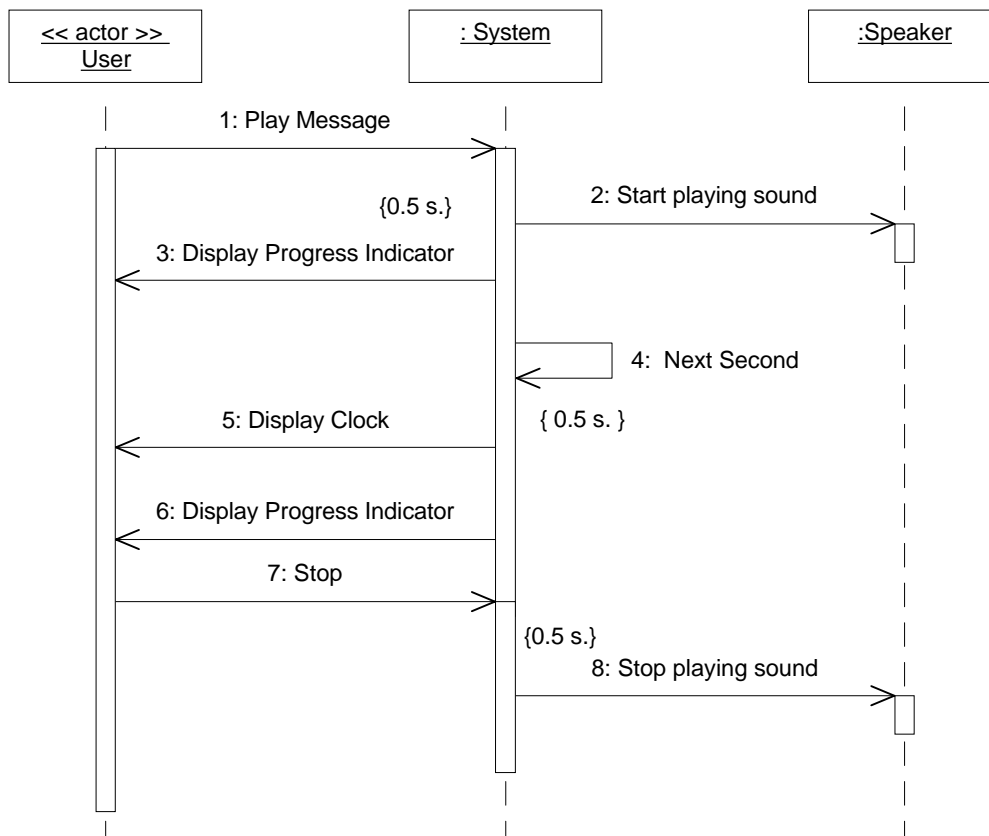
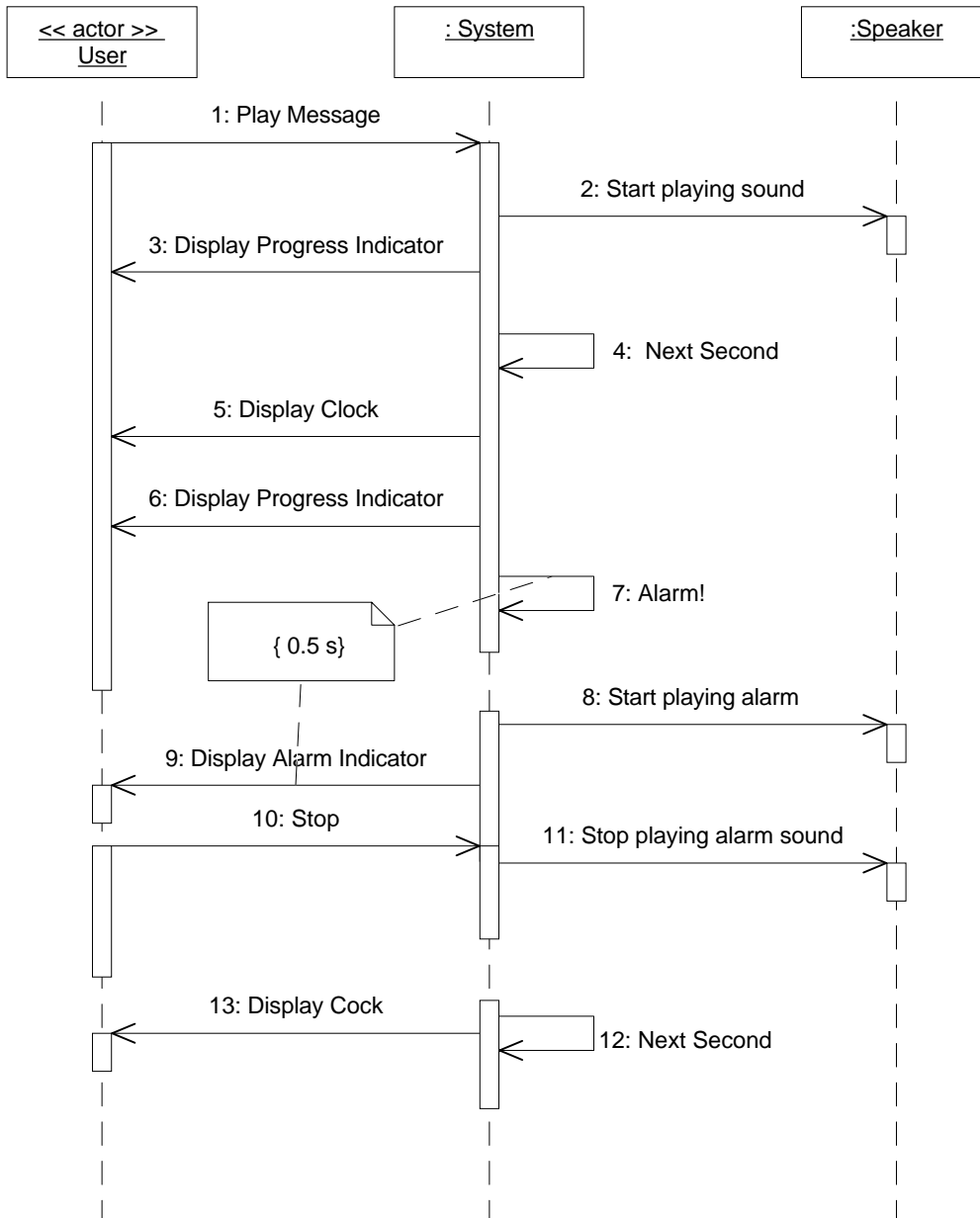

Figure 2.4: Playing message scenario

Figure 2.5 shows what should happen when the alarm sounds while the user wants to play a message. We have decided to give priority to the alarm sound.



**Figure 2.5: Alarm while playing scenario**

The system can switch on and off the screen backlight, the microphone and the speaker. These elements use a considerable amount of battery power. By switching them off the system saves energy and increases the battery life.

The battery can also warn the system when it is almost out of energy. Then the system should switch off all the peripherals and enter the stand-by mode. When the user charges the battery, the system will leave the stand-by mode. While the system is in stand-by mode, the messages are still kept in the memory.

Figure 2.6 shows a scenario where the system enters stand-by mode, then it is woken up by the alarm clock. After another battery warning, it enters again stand-by mode.



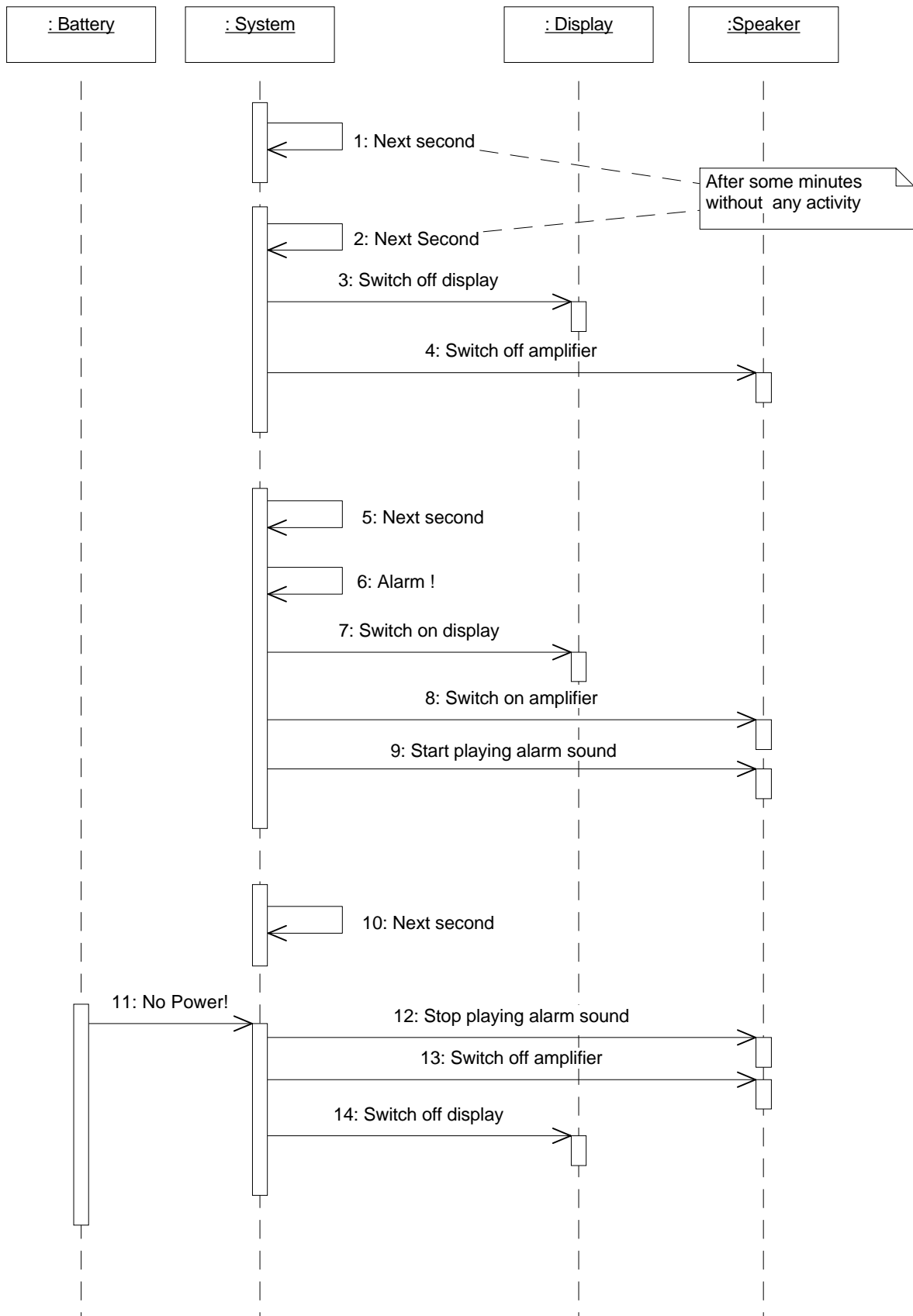

**Figure 2.6: Entering and exiting stand-by mode scenario**

### 3 Analysis: Object structure

After the requirement analysis, [SS95] proposes the Domain Analysis phase. In this phase, we should analyse the requirements and present a class diagram as a general solution for the problem. The domain diagram shows the main classes of the system and their relations, but it omits their interface.

The first step in building the class diagram is identifying the objects involved in it.

#### 3.1 Identifying objects

<b>Active Objects</b>	Message Player & Recorder A “digital tape”.
	Buttons, Screen The user can press the buttons. The screen shows a menu and indications to the user.
	Alarm Clock It shows the time and it can wake up the user
<b>Services</b>	Battery level sensor Measures the remaining battery power level
	Analogue to digital converter The interface between the microphone and the processor
	Digital to analogue converter The interface between the processor and the microphone
	Screen controller Generates the image on the LCD screen
<b>Real-World Items</b>	Date
	Time
<b>Physical Devices</b>	Speech, Sound
	Microphone, Speaker
	Battery
<b>Key Concepts</b>	Keyboard, Display
	Speech, Sampling, Sound sample We must study how a discrete digital system can capture and process an analogue and continuous sound signal.
<b>Persistent objects</b>	Sound message
	Collection of recorded messages The contents of the digital tape
	Current Time, Date
<b>Transactions</b> <b>Visual elements</b>	Alarm Time When to warn or wake up the user
	Message
	Menu, Menu option, Menu selection
	Clock, Alarm on/off indicator
	Calendar
	Status bar, help line, Task progress indicator
	Play , Record, Stop, Yes, No, Up, Down, Left, Right Buttons The user interacts with the system by pressing the buttons. There are nine different buttons



**Figure 3.1: User Interface**

The visual elements of the user interface are shown in the Figure 3.1. The interaction with the user is menu-driven and the display always shows the current menu. The top line shows the current time, date and the alarm time. At the bottom, there is a short help message for the user.

### 3.2 Building the class diagrams

#### The Sound Recorder Class Diagram

The user interacts with the system through the display and the keyboard. These are somehow passive objects, so we decide to add a user interface object that manages the interaction with the user. The User Interface class relies on the Audio Controller to perform the tasks. The Audio Controller is the core of the system and it executes the tasks *suggested* by the user interface. The audio controller uses the Audio Input and Audio Output classes to produce the sounds. These classes are related with a microphone and speaker hardware wrapper [AKZ96]

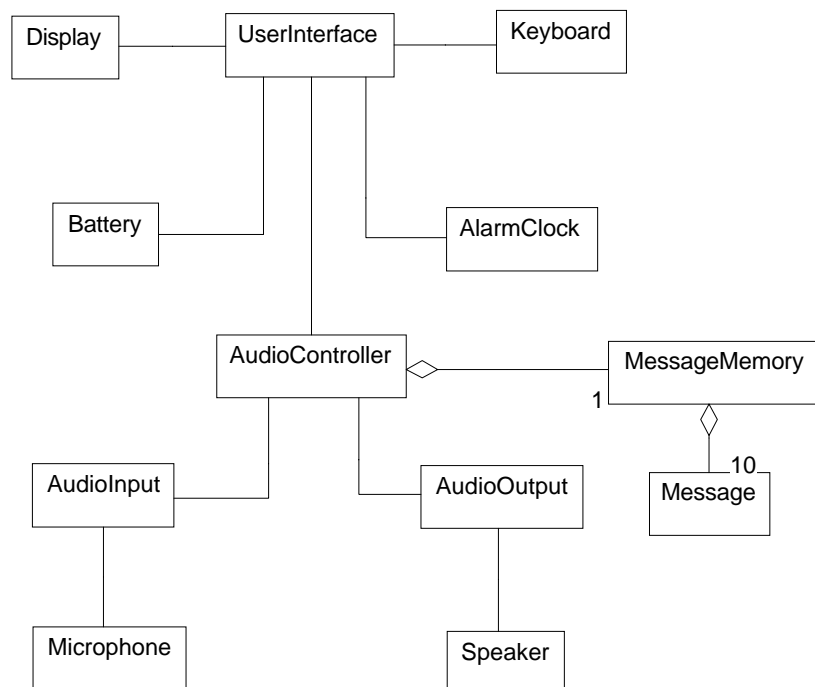
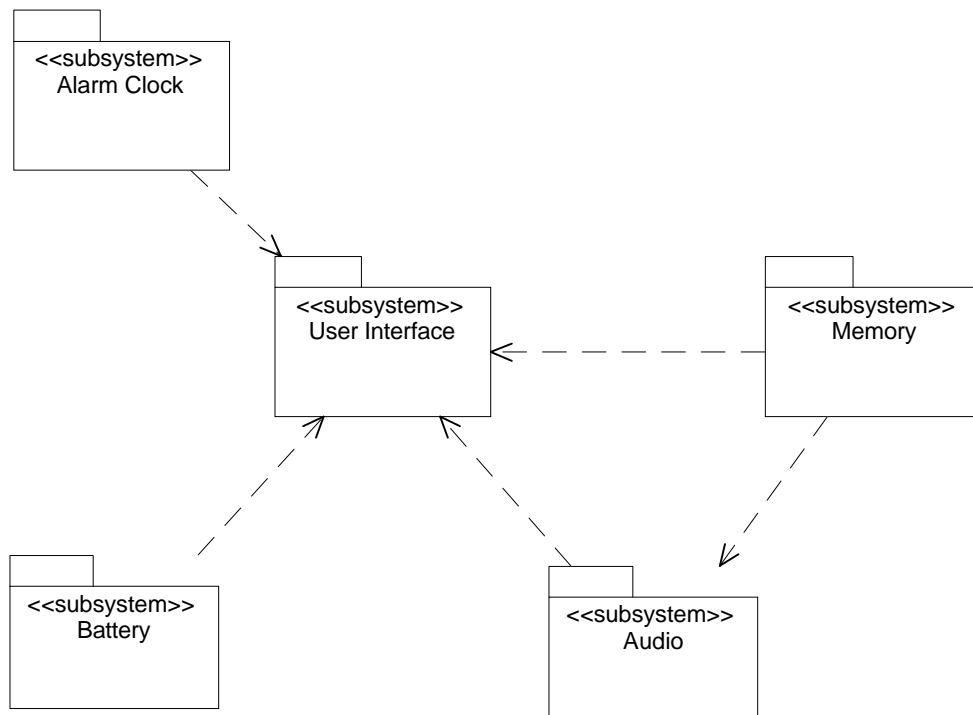

**Figure 3.2: Sound Recorder class diagram**

The messages are stored in the message memory. This class keeps a directory with th recorded messages, allocates spaces for the new messages, and deletes the old ones.

The Alarm Clock updates the internal clock and checks when to sound the alarm. In this case, it notifies the event to the User interface, so the User interface can show an indication on the display and play an alarm sound with the help of the Audio Controller. The Battery object periodically measures the battery power level. When the battery goes low then it reports the event to the User Interface.

Figure 3.2 represents graphically the main classes of the digital sound recorder. The class diagrams provide a general overview of the whole system by abstracting from the details of each class. We have divided the class diagram into five different subsystems: the alarm clock, the battery, the user interface, the memory and the audio subsystem. This division is represented in Figure 3.3. The following sections study and develop each subsystem a bit further.



**Figure 3.3: Subsystems in the sound recorder**

### The Audio Subsystem Class Diagram

Each message is composed of several audio blocks and each audio block if composed of many sound samples. The Audio subsystem always records or plays a complete audio block.

The Audio Input and Audio Output classes have real-time requirements. The Timer class provides accurate timing for the Audio Input and Output classes. The timer class is a wrapper for a hardware timer.

The Microphone class is a hardware wrapper for the physical microphone. A Microphone class can record one sound sample. The Speaker class is able to play back sound sample through the hardware speaker.

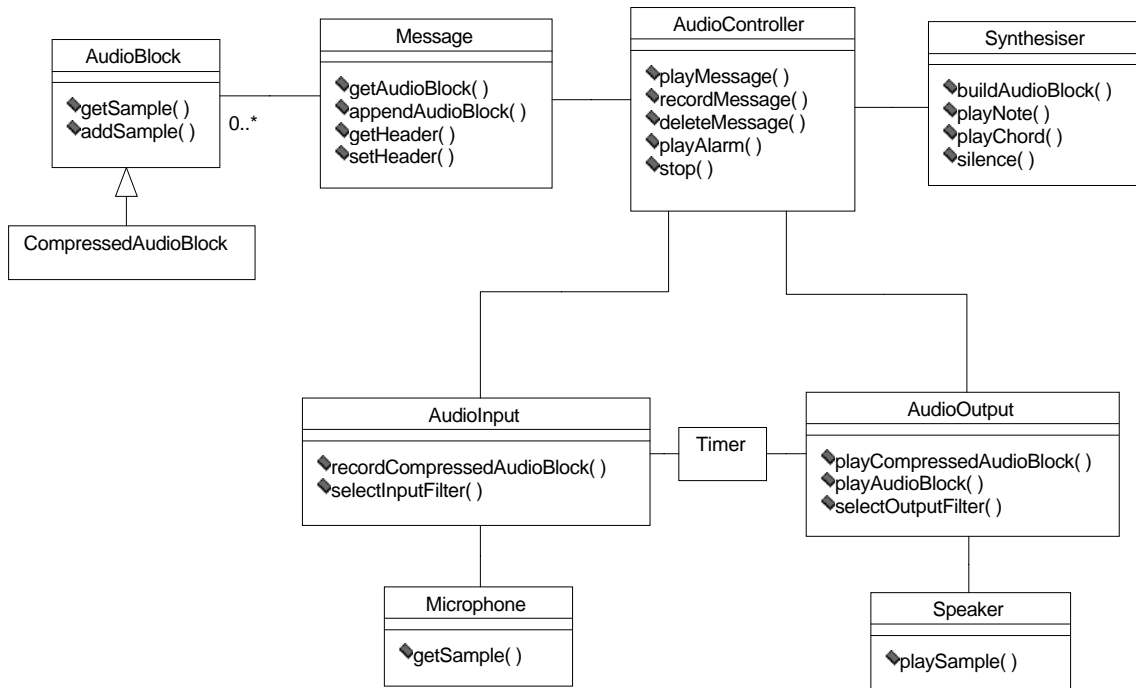

**Figure 3.4: Audio subsystem class diagram**

Why do we need three different classes to play a message? Playing or recording a message is a complex task that requires a precise timing and interaction with the hardware. We also believe that by splitting the representation of the messages from their process we increase the flexibility of the design. This design can be easily extended to stereo messages with two channels of audio blocks or pipelined compression, where the sound is compressed while it is recorded.

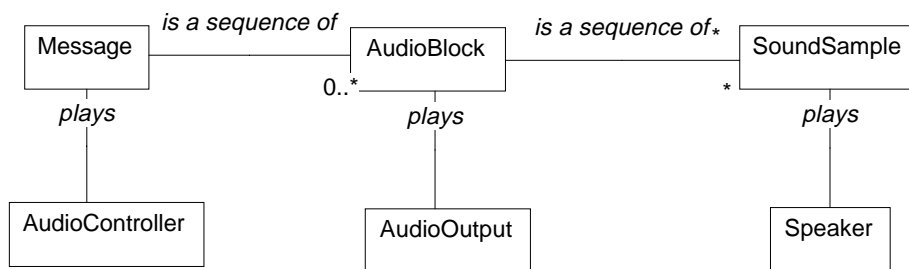
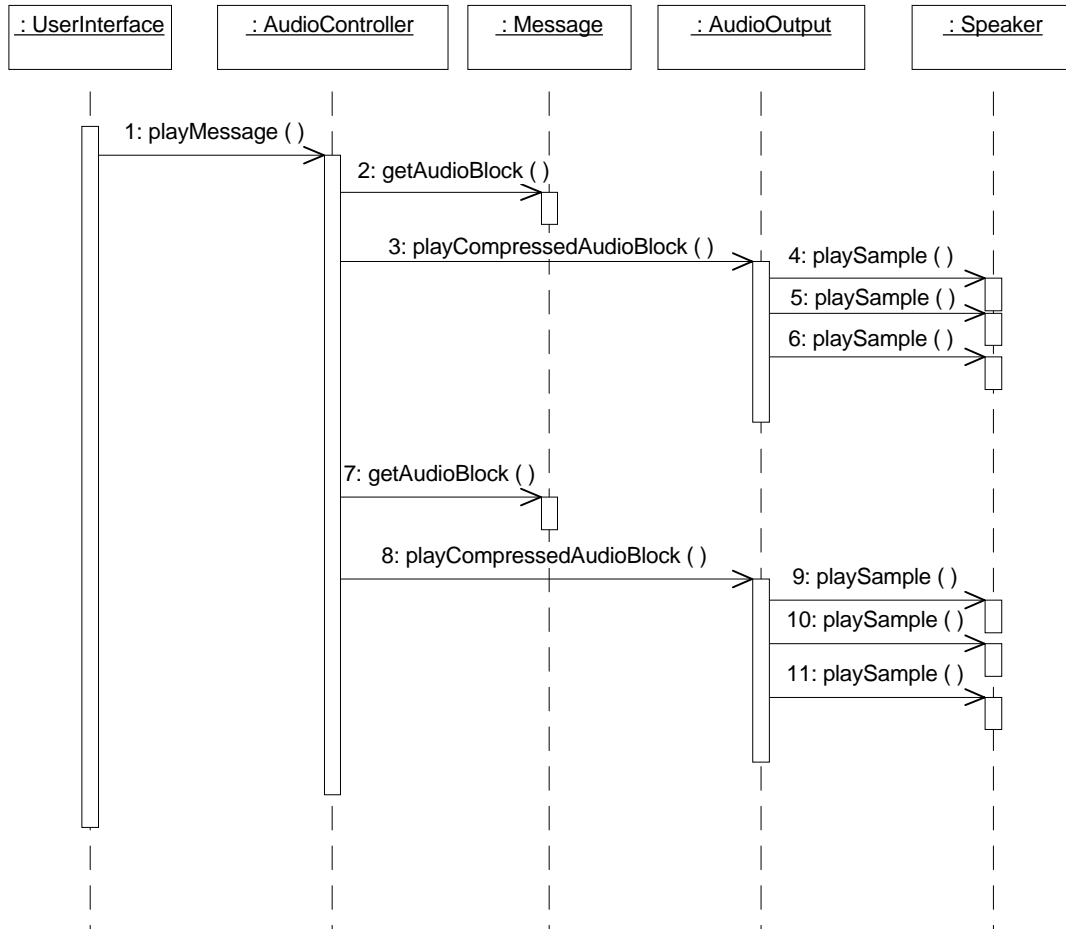

**Figure 3.5: Internal representation of sound messages**

Figure 3.5 shows the decomposition of a message into audio blocks and sound samples. It also shows what class is responsible to play each element.

<b>Granularity</b>	<b>Play</b>	<b>Record</b>
Sound sample 1/6000 <sup>th</sup> of second	Speaker .playSample()	Microphone. .recordSample()
AudioBlock 2000 samples, 1/3 <sup>th</sup> of second	AudioOutput .playAudioBlock()	AudioInput .recordAudioBlock()
Message (variable length) E.g. 60 AudioBlocks, 20 s.	AudioController .playMessage	AudioController .recordMessage()

Figure 3.6 shows the messages exchanged in order to play a message. This diagram has been simplified to improve its readability. Actually, an AudioOutput object will invoke the playSample method 2000 times per audio block.

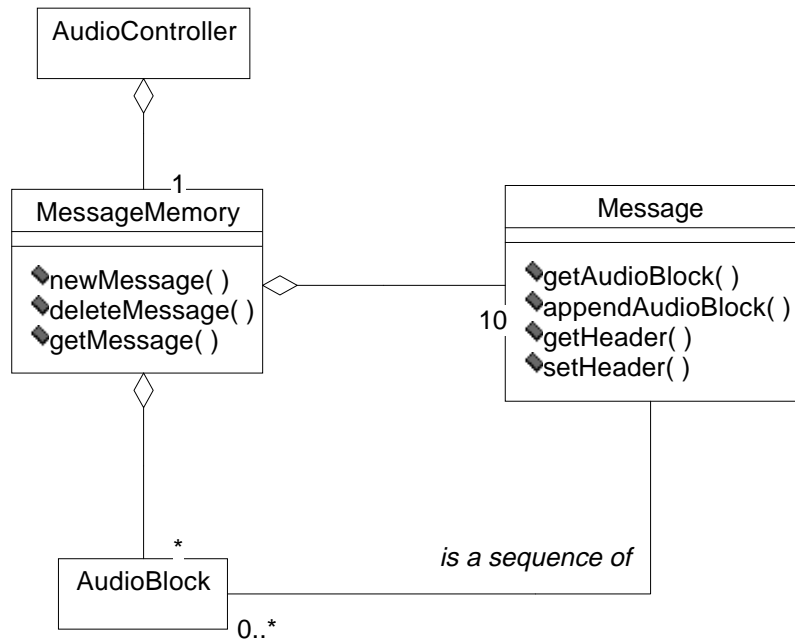

**Figure 3.6: Play message sequence diagram**

### The Message Memory Subsystem Class Diagram

The message memory class manages the storage space of the sound recorder, it keeps a directory of recorded messages and it allocates space for new messages. The class diagram for the memory subsystem is shown in Figure 3.7

The User Interface uses the Message Memory for obtaining the list of recorded messages, but it does not modify it. The Audio Controller is the only class that uses the modifiers of the Message Memory. If the User Interface wants to delete a message, instead of accessing directly to the Message Memory object, it uses the deleteMessage method of the Audio Controller. This mechanism prevents the User Interface from deleting a message while the Audio Controller is playing or recording it. Figure 3.8 represents this scenario.



**Figure 3.7: Message memory class diagram**

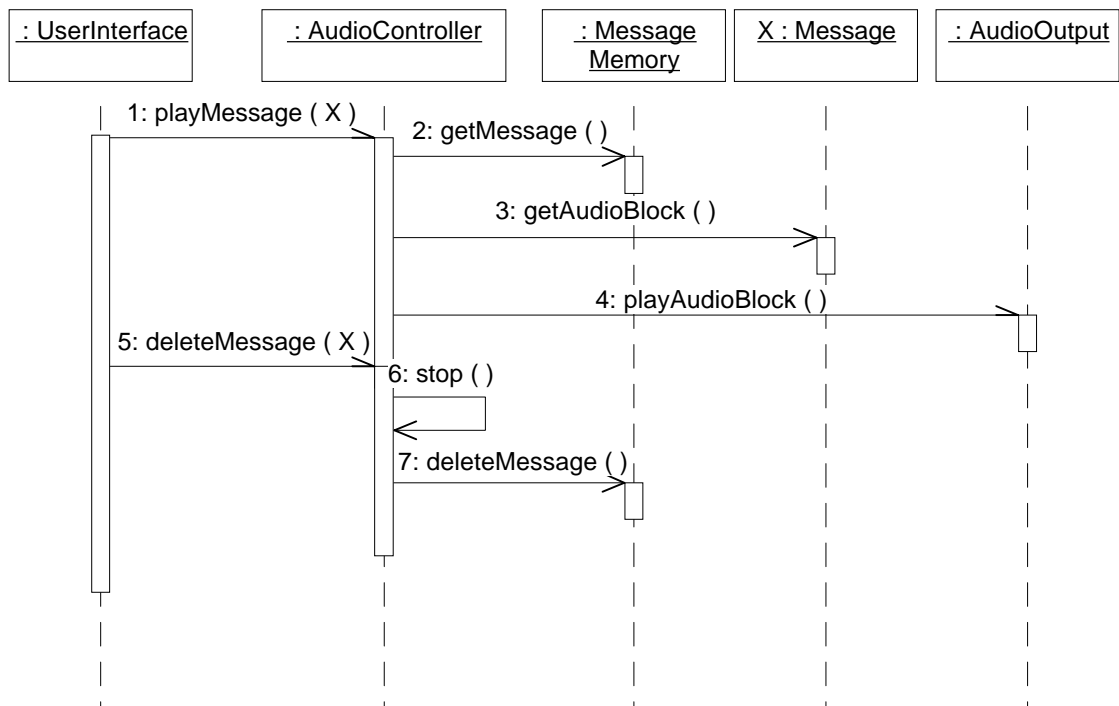

**Figure 3.8: Deleting a message while playing it**

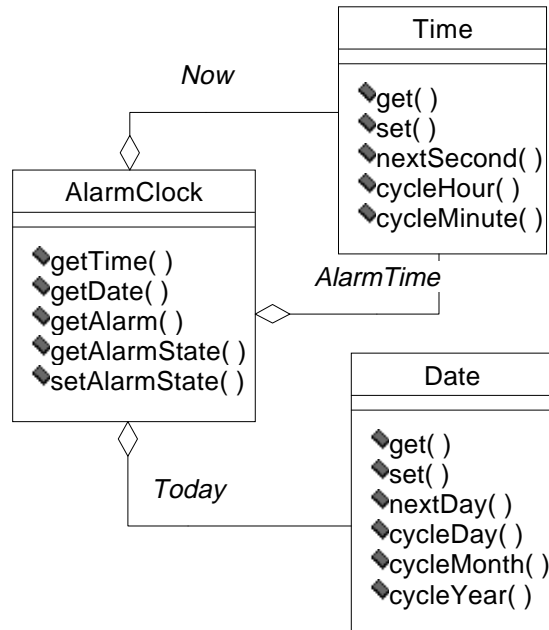

**Figure 3.9: Alarm clock class diagram**

### The Alarm Clock Class Diagram

The Alarm Clock class keeps the current time and date and the alarm time. The Alarm Clock uses a timer to measure the pass of the time. Each second updates the internal representation of the time, by using the nextSecond method. When the Time object wraps around, then the date is updated using the nextDay method. The class diagram for the Alarm clock is shown in Figure 3.9.

### The User Interface Class Diagram

The User Interface class manages the interaction with the user. It receives the input from the user through a keyboard and gives feedback to him or her through a display.

The Display class is the interface to the hardware display. It can be switched on or off in order to save energy. The Graphic Context abstraction is used to draw on a Display. It provides some basic drawing primitives like drawing points, lines, text strings or filling rectangular regions with a flat colour. Each Graphic Context represents a rectangular area of a Display. The Graphic Context manages the geometry transformation from its local coordinate system to the global one.

The View classes use these graphic primitives to render the application objects like the current time or the user menu. Each View uses a different Graphic Context to draw on. Figure 3.10 shows a visual representation of these objects.

The User Interface also receives messages from the Alarm Clock and the Battery. Some events, like when the battery goes low, are modeless; that is, the system always reacts in the same way whenever the event is present. These modeless events are managed directly by the User Interface object.

However, the system reacts to some other events, like when pressing a button, depending on the current User Mode. When the user presses the “down” button, the system can select the next option in a menu or it can decrease the current time. These events are called modal, and they are forwarded from the ‘generic’ User Interface event handler to a more concrete User Mode class.



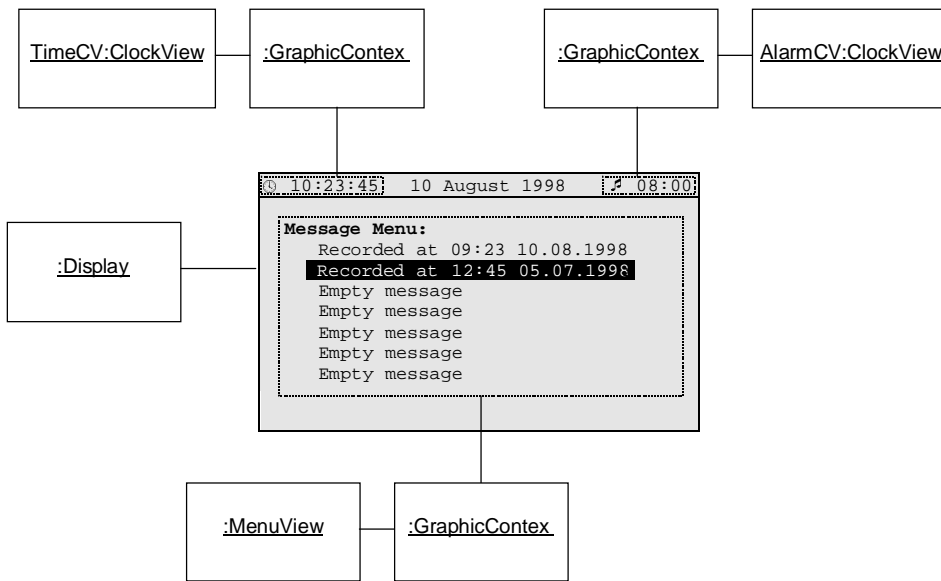

**Figure 3.10: Visual representation of graphic objects.**

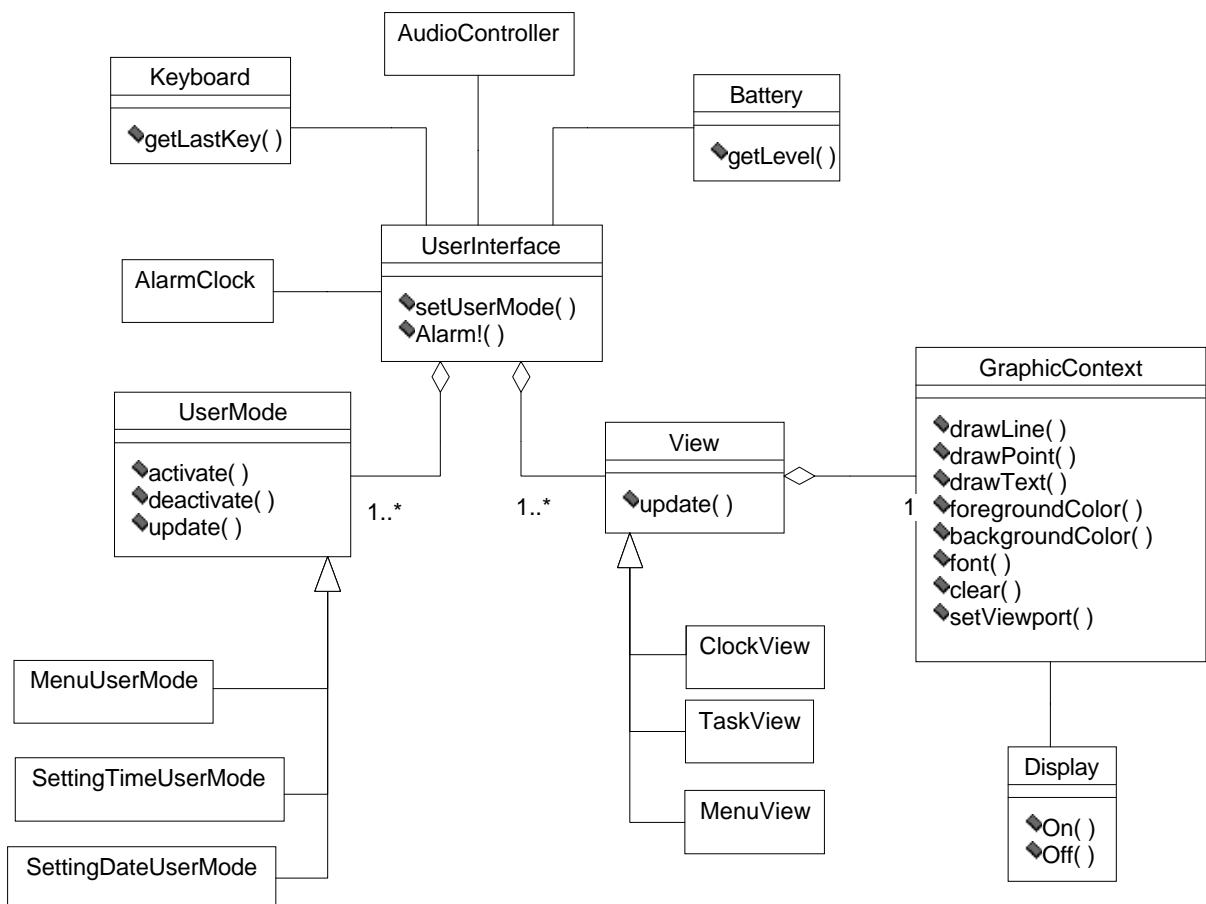

**Figure 3.11: User interface subsystem class diagram**

The Menu User Mode class and the Menu View class can allow the user to choose from different options on a screen menu.

The Setting Date and Setting Time User Modes allow the user change the current date and time. They use the Date View and Time View objects to render the date and time on the screen.

#### 4 Analysis: Defining Object Behaviour

A class diagram presents a static view of our system. To understand the behaviour of our system we should create new diagrams showing the dynamic aspects of our design. The statechart, collaboration and message sequence diagrams describe the dynamic behaviour of a system. We will use statecharts to shows the internal evolution of a single object.

##### Audio Controlle

An Audio Controller object is the referee for the sound channels. A sound channel can be used to record a message, to play a message or to play an alarm sound.

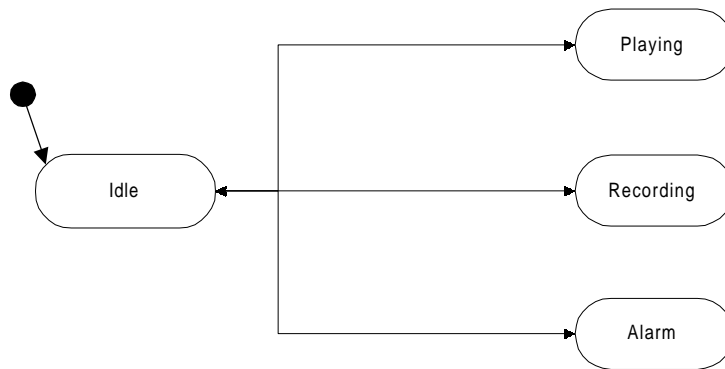

Figure 4.1: Behaviour of an AudioController

##### Audio Input

An audio input object controls an input sound channel. It records an audio block from a microphone object with the help of an DMA channel. After recording the block the sound is compressed. The behaviour of an Audio input object is represented in Figure 4.2.

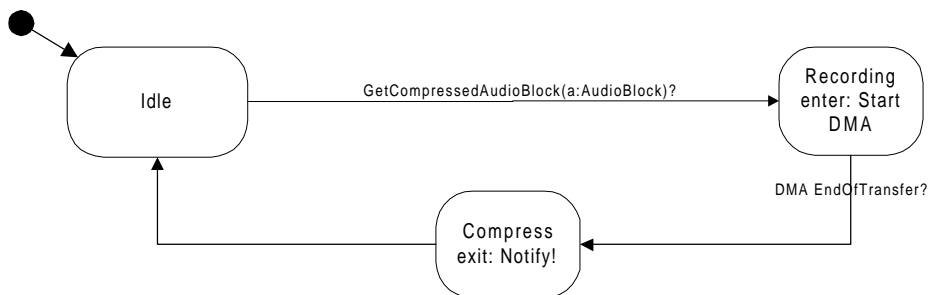
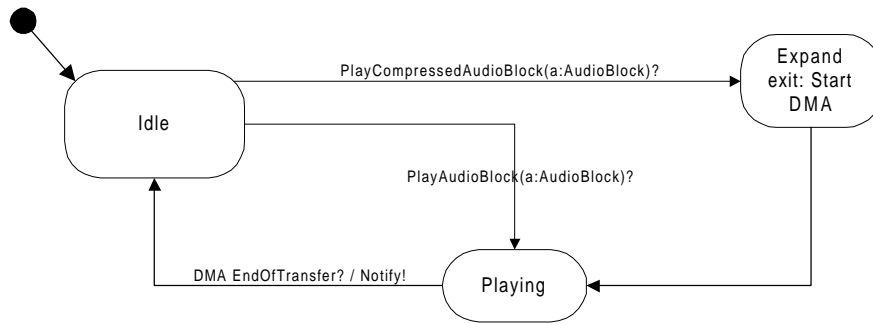

Figure 4.2: AudioInput statechart

##### Audio Output

An Audio Output object controls an output sound channel. It can play an audio block through the speaker.



**Figure 4.3: AudioOutput statechart**

### Microphone

A microphone object is a wrapper for a real microphone. The input amplifier can be switched on and off. When the microphone is on, it captures sound samples periodically.

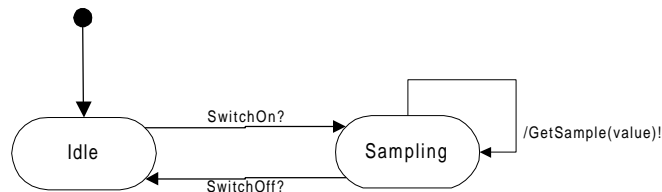

**Figure 4.4: Microphone statechart**

### Speaker

A speaker object is a wrapper for the real speaker. There is an output amplifier, that can be switched on and off.

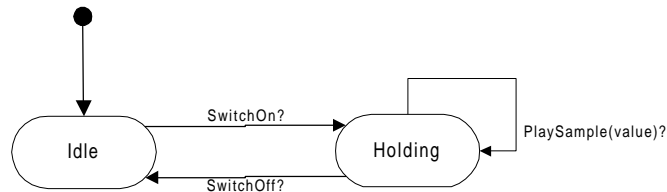

**Figure 4.5: Speaker statechart**

### Timer

A hardware timer measures the pass of the time. A timer object is a wrapper for the hardware timer device.

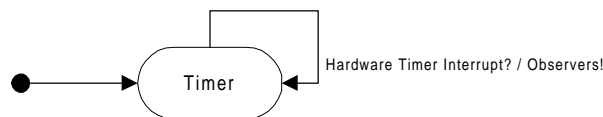

**Figure 4.6: Timer statechart**

## 4.1 The User Interface

### Menu User Mode

The menu user mode is the main user mode for the user interface. The buttons allow the user to navigate through the menus and invoke the desired menu option. The “up” and

“down” buttons select the next and previous menu option. The “right” and “yes” buttons invoke an option. The “left” button is used to go to the previous menu.

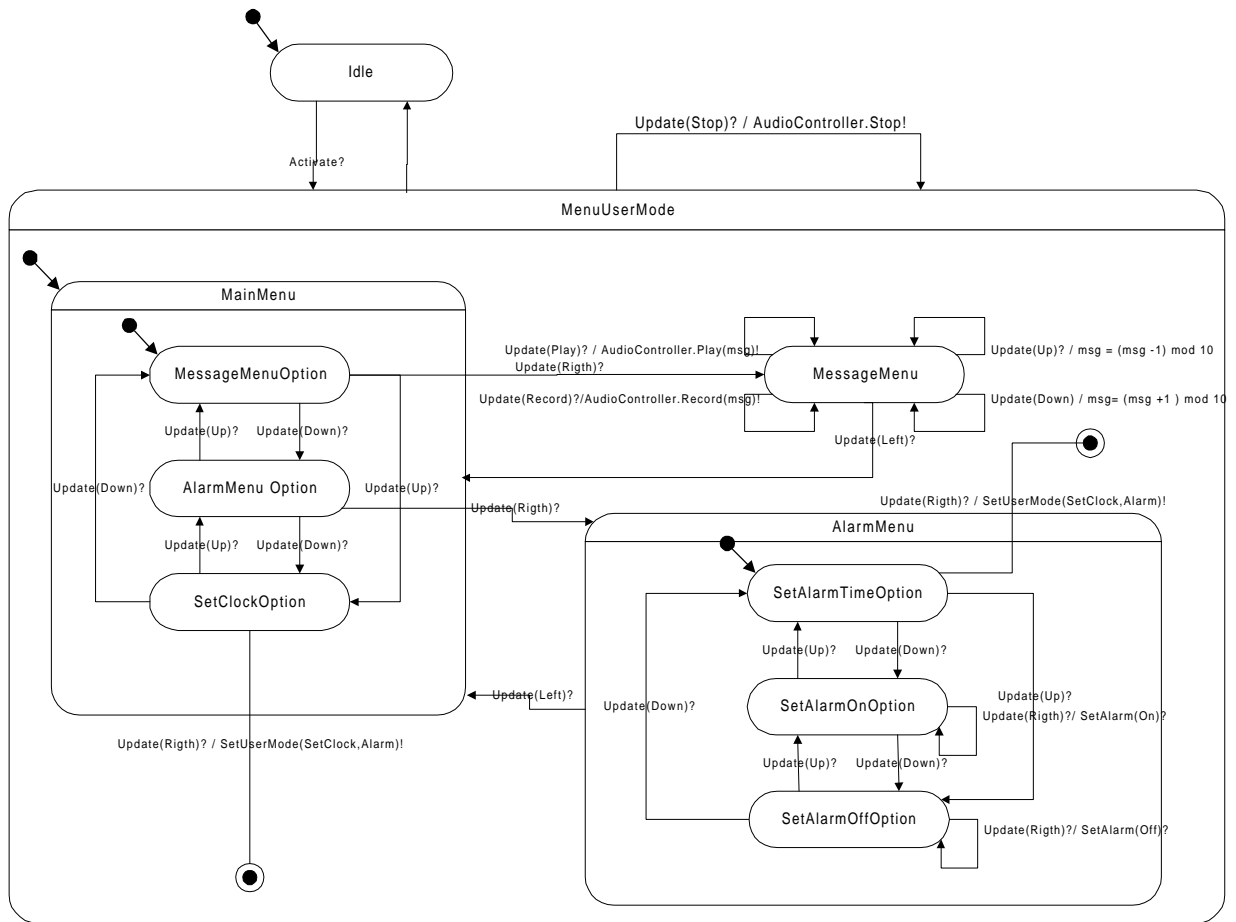

**Figure 4.7: MenuUserMode statechart**

### Setting Clock User Mode

The setting clock user mode is used to change the current time or the alarm time. The “left” and “right” buttons switch the active field between the minute and the hour field. The “up” and “down” buttons modify the active field.

### Setting Date User Mode

The setting date user mode is used to change the current date. The “left” and “right” buttons switch the active field between the day, month and year field. The “up” and “down” buttons modify the active field.

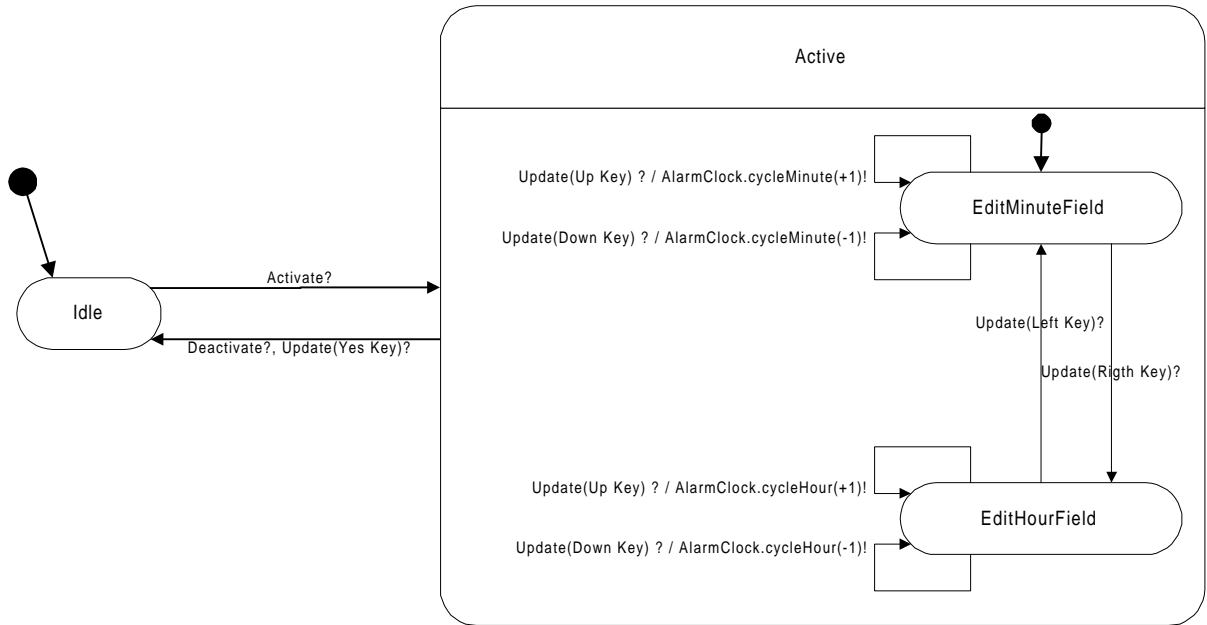

**Figure 4.8: SettingClockUserMode statechart**

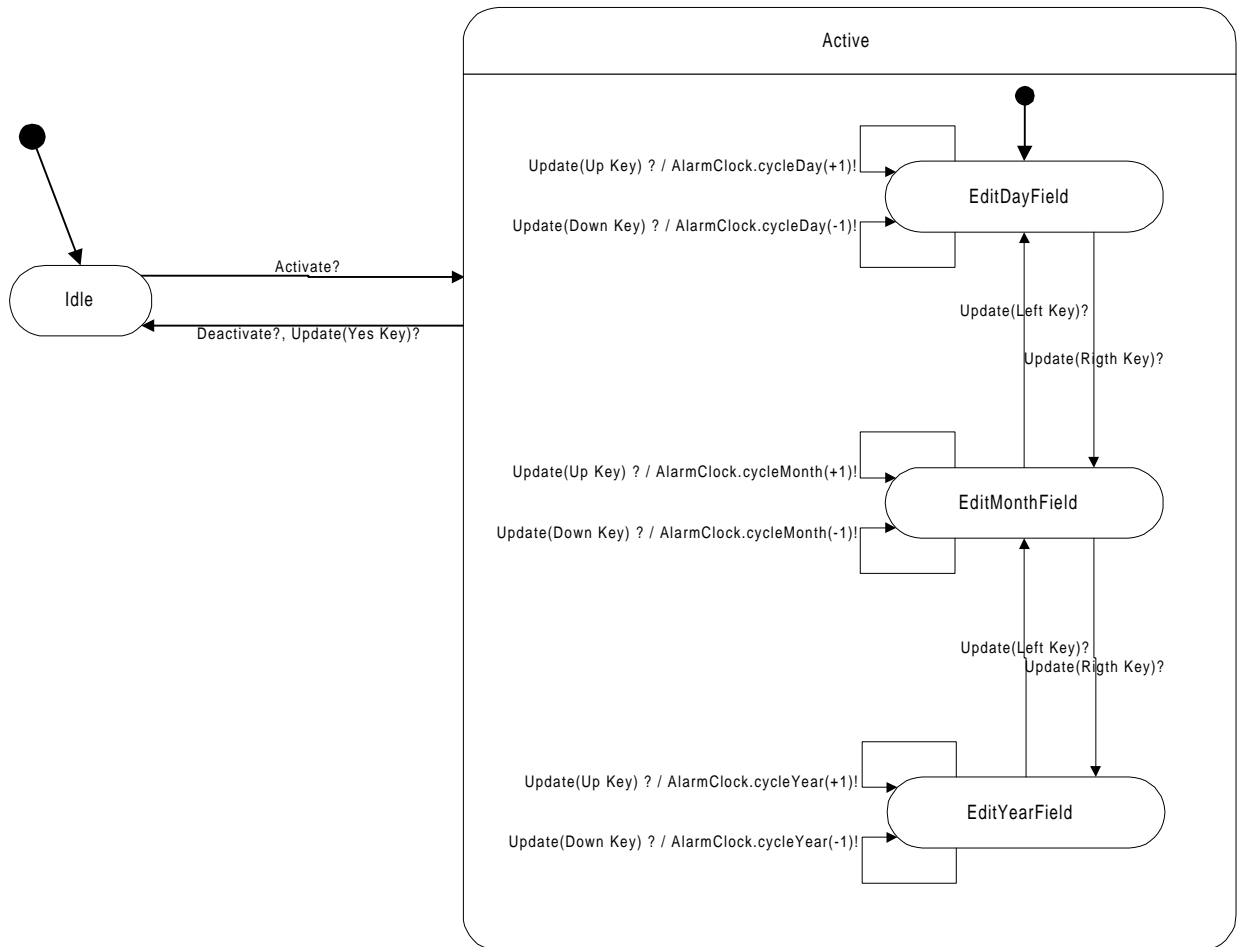

**Figure 4.9: SettingDateUserMode statechart**

## **5 Architectural Design**

In this section, we will describe the hardware resources allocated for the design. In our final product, the design of the hardware is as important as the software. A hypothetical customer will not buy a program or a hardware device but a shrink-wrapped product containing both elements.

However, we did not try to optimise any aspect of the hardware of the sound recorder. For example, the processor we are currently using has more power than needed. It is probably more expensive, bigger and it needs more energy than a less powerful processor. Nevertheless, this extra processor power allows us to focus more in the design aspects of the system and ignore the implementation issues and optimisation tricks of a particular processor.

### **5.1 Physical architecture**

The main processor is a Hitachi SH7032 running at 16Mhz with 8Kb of on-chip RAM. This embedded processor is built around a processor core and several built-in peripherals. The processor core is a conventional RISC integer pipeline and its task is to execute the machine code instructions. The built-in peripherals consist of an analogue to digital converter, several timer and counter units, DMA channels and a watchdog. The manual [HSH1] describes the instruction set of the processor core. The hardware and built-in peripherals are described in [HSH2]. Figure 5.1 shows the proposed architecture.

The prototype version of the systems is equipped with 64Kb of EPROM, 256Kb of SRAM and 128Kb of video RAM. The EPROM contains the boot code and a debugger. There are two serial ports for downloading and debugging the software. They are connected to the processor serial channels and are RS-232 compatible thanks to an MAX232. The EPROM also contains code to initialise the serial ports, send and receive data up to 38400 bps.

The analog to digital converter has seven input channels. The converter can sample at more than 60Khz with a resolution of 12 bits. The main board is described in [HEVB]. We use the analog to digital converter to record the sound from the microphone. The sound is played through the speaker by using an external D/A converter, an AD7524.

The LCD Display [HLCD] is 320x240 pixels, black on white, transmissive, with CFL backlight. The LCD Controller is a Yamaha YGV610B and supports 16 grey levels. The LCD controller generates all the necessary signals for the LCD display. It has its own video memory. It is attached to the main processor through its system bus. The LCD controller ports and the video memory are mapped into the memory address space of the processor.

### **5.2 Architectural Patterns**

The software of the sound recorder does not have special safety or reliability requirements. The architecture will not support hardware fault tolerance. Probably, the user will damage the unit, by dropping it to the floor or by spilling some liquid into it, before the hardware wears out.

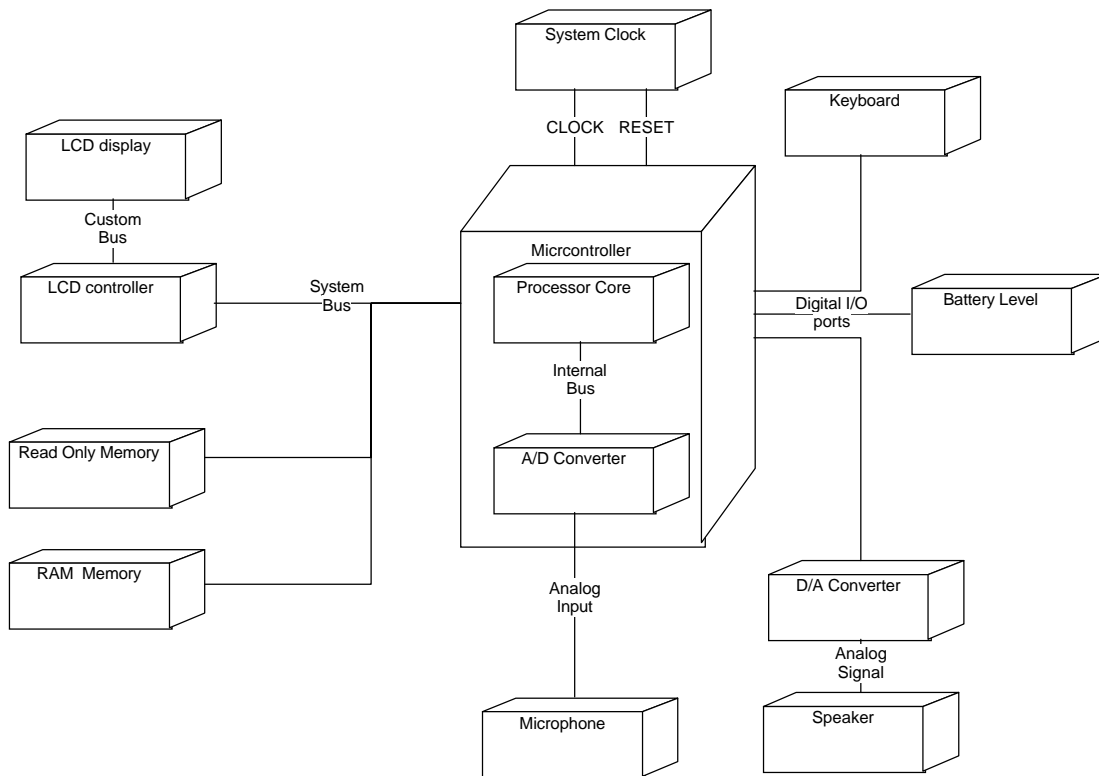

**Figure 5.1: Hardware architecture of the digital sound recorder**

A watchdog will restart the system in case of a sporadic fault. When the watchdog resets the processor, the message memory will be lost.

Since it is a wrapped and embedded solution, the sound recorder does not have any communication link with other systems. It is not necessary to provide a communication link for testing and diagnosing purposes because the system is quite simple and it can be tested following indications on its own display. Actually, it was not designed to be tested or repaired.

All the peripherals are accessed through the memory address space of the processor. Since they are tightly coupled, they do not require the use of special communication patterns.

### **5.3 Concurrency design**

The concurrency model must specify the different execution threads of the software and the communication mechanism between them.

We decided to not use a real-time operating system in this design in order to keep it as simple as possible. We plan to introduce a real-time operating system in future designs. In this design, there are two execution threads. The user thread is an interactive thread and manages the interaction with the user through the display and the buttons. The audio system thread executes the reactive and real-time objects.

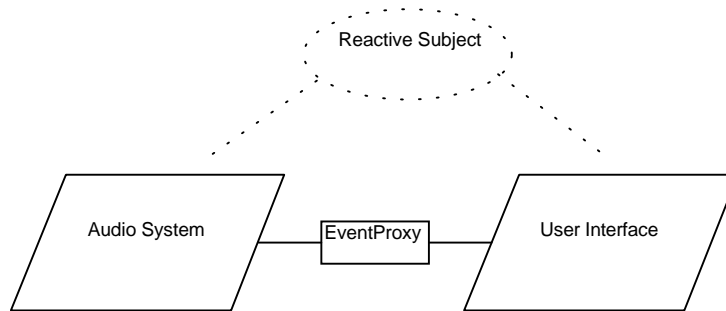

**Figure 5.2: Task diagram**

The audio system thread is activated whenever the processor acknowledges an interrupt request. The system thread has priority and it can pre-empt the user thread. There is a scheduler object running in the context of the system thread that schedules the execution of other objects. A hardware timer periodically activates the scheduler. Then it processes the task list. Each element of the task list contains a pointer to a method and the period for that task. The scheduler is non pre-emptive. The tasks are meant to be fast and return the control to the scheduler as soon as possible. Two objects running in different threads communicate by using the Reactive Subject pattern, described in chapter 10.

## 6 Mechanistic Design

In this chapter, we will discuss how the different software objects collaborate to achieve their objectives. Chapter 4 presented the internal behaviour of each individual object. We described how the state of each object changes when it receives a message. Now, we will focus on how and when the objects exchange messages. We will use software patterns to describe the external behaviour of several different objects that work together.

### 6.1 Collaboration between the Hardware and the reactive objects.

We can consider the hardware as an agent. This new agent may enclose some other agents defined in the analysis phase. The hardware notifies to the running program an event by means of an interrupt request. When a hardware device wants to communicate some event to the system software, it requests an interrupt. At some point in the time the processor will acknowledge the interrupt, stop the current program flow and call a interrupt service routine. This routine should attend the hardware request and should return as soon as possible to allow the normal program execution flow to continue. Unfortunately, the interrupt service routine or ISR can not be a method of an object. The ISR does not have any context information associated and thus can not carry 'this' or 'self' pointer required in most OO languages. Therefore, the designer should build a mechanism that transforms a hardware interrupt in message to an object. We have wrapped this mechanism in an abstract class called ISR. A subclass of the ISR class can implement interrupt service routines as a normal method.

### 6.2 Collaboration between the reactive objects and the User Interface

The keyboard, the battery level meter, the alarm clock and the audio controller collaborate with the user interface by using the Reactive Subject pattern. The reactive objects send events to the event proxy but do not wait for the user interface to read



them. The user interface constantly checks for new events in the event proxy. When it finds one, then it delegates the responsibility into the views and controllers.

### 6.3 Collaboration between the Scheduler and the Alarm Clock, the Keyboard and the Battery Level Meter.

The Scheduler object provides accurate timing and scheduling for the time dependent objects, like the alarm clock.

The alarm clock object subscribes itself to the scheduler object. Every second, the scheduler will notify to the alarm clock that a second has been elapsed.

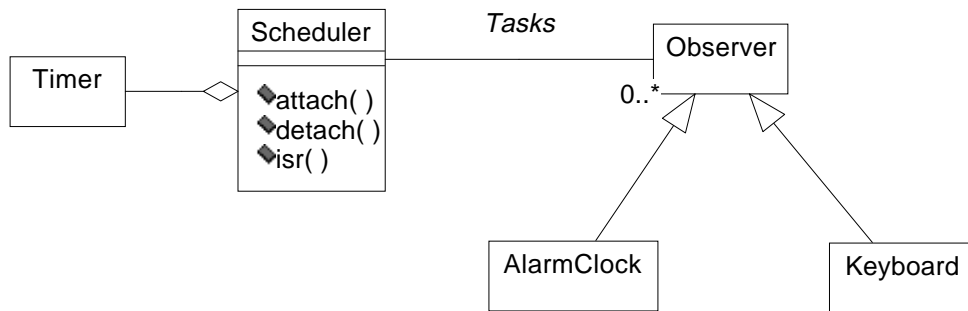

Figure 6.1: Scheduler class diagram

The Keyboard object needs to periodically sense the status of the physical keys. We decide to poll the keyboard ten times per second. To miss a key, the user has to press and release a key in less than one tenth of second.

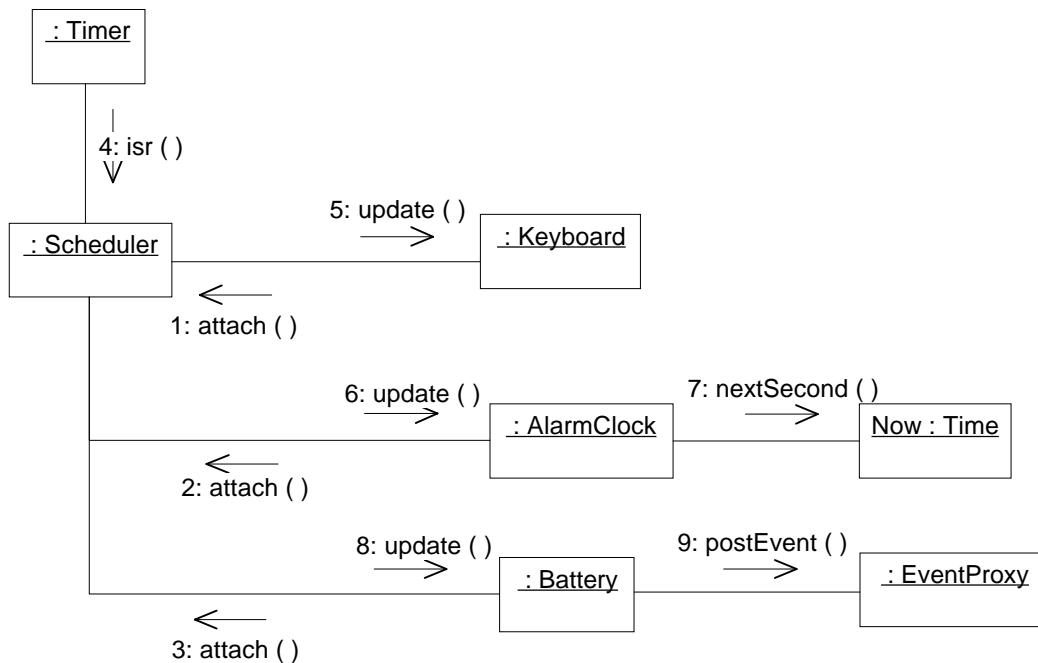

Figure 6.2: Collaboration between the scheduler and its clients

The physical keyboard could also generate a hardware interrupt when a key is pressed. Compared to the polling method, an interrupt-based method reduces the CPU overhead but increases the necessary hardware.

The Battery Level Meter measures the voltage supplied by the battery every five seconds.

The Keyboard and the Battery level Meter also use the services of the scheduler in order to be activated periodically. Figure 6.2 shows how the scheduler periodically wakes up the reactive objects of the system,

#### ***6.4 Collaboration between the Message Memory, Message objects and the Audio Controller***

The Message Memory is a container for Message objects. This collaboration follows the Container pattern. The Audio Controller uses the Message Memory whenever it needs access to a Message object.

#### ***6.5 Collaboration between the Setting Time User Mode, the Alarm Clock the Keyboard and the Clock View objects.***

These objects follow the Model View Controller pattern. The Alarm Clock provides a model for the Clock View object, which renders the time into the display. The User Mode objects control the interaction with the user. Since the Alarm Clock is a reactive object and the Clock View an interactive one, they also collaborate using the Reactive Subject pattern. The Keyboard object reports the user key presses to the user interface by using the Reactive Subject pattern also. Figure 6.3 shows the sequence of messages produced when the user presses the “up arrow “ button while the current user mode is the SettingTimeUserMode.

#### ***6.6 Collaboration between the User Interface, the Audio Controller, the Messages and the Audio Output objects.***

The User Interface and the Audio controller use the Reactive Subject Pattern.

The Audio Controller, Message and Audio Input and Audio Output collaborate using the Observer Pattern.

Figure 6.4 shows the sequence of messages sent to play a message. In order to simplify the diagram, the message is composed of just one audio block. This collaboration is rather complex, but it supports playing and recording two different messages simultaneously. It will also support recording and playing stereo sound, where each message is composed of two streams of audio blocks.

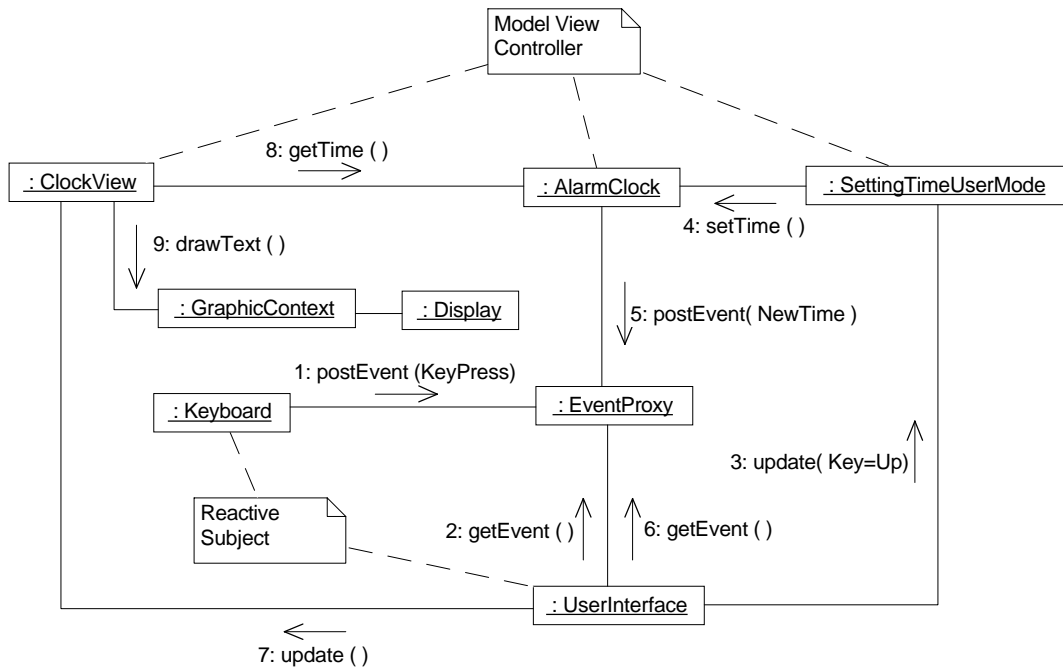

**Figure 6.3: A Model-View-Controller collaboration**

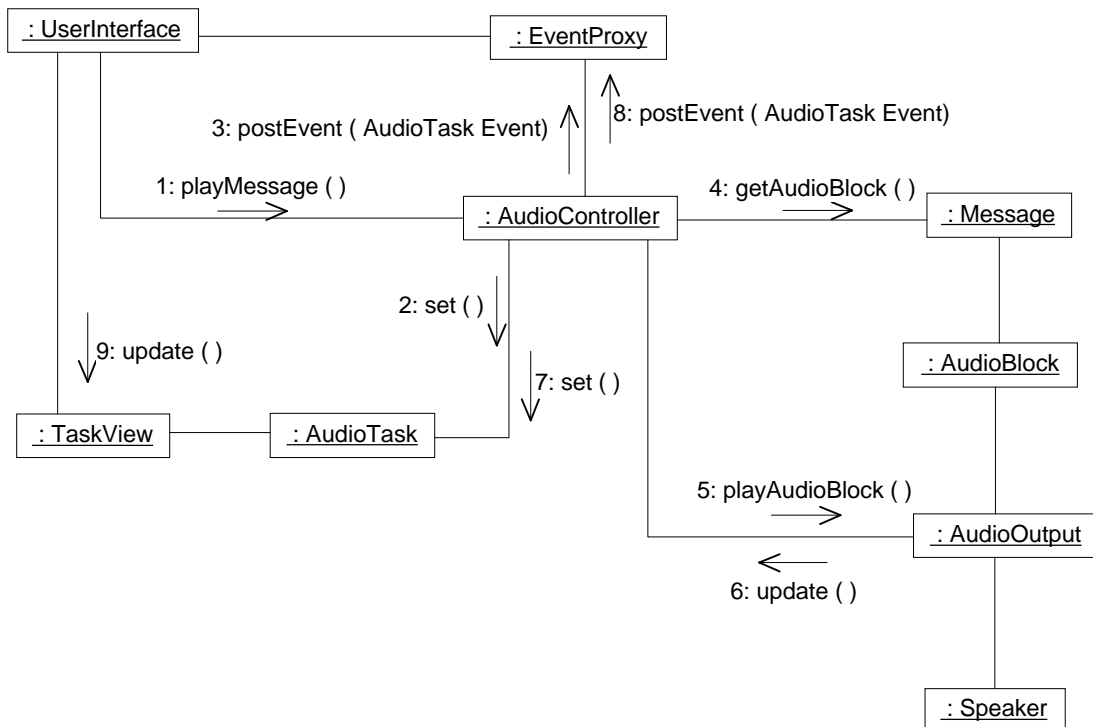

**Figure 6.4: Collaboration between the User Interface and the Audio Controller**

## 7 Detailed Design

### 7.1 *Objects modelling the hardware*

A hardware wrapper is a software object representing a hardware device. It is an interface between the application objects and the physical devices. The constructor method of a hardware wrapper initialises the hardware device. After the creation of the wrapper, the device is ready to be used. The methods of the wrapper configure the device, but also can start or stop some activity. Usually a wrapper has few attributes, because the state of the wrapper is the state of the hardware device.

The detailed design and implementation of a hardware wrapper requires a precise knowledge of the hardware devices. In this design, the speaker, microphone, timer and keyboard objects are some examples of hardware wrappers.

### 7.2 *Sound Compression Algorithm*

One of requirements specifies that the sound must be recorded at 6Khz, using eight bit samples. This means that for every recorded second, we need almost 6KB of memory. In order to reduce the amount of memory used we can apply a compression algorithm to the input signal. One of the simplest audio compression algorithms is the Adaptive Delta Pulse Code Modulation (ADPCM) [ITU727]. ADPCM is easy to implement and has a low CPU overhead.

### 7.3 *Using Direct Memory Access Channels*

To record sound, an Audio Input object needs to move 6000 samples from the microphone to an audio block each second. There are several ways to perform this task. One alternative is to use the scheduler to time the task. A timer activates the scheduler 6000 times per second and then the scheduler activates the audio input object that transfers the sample. Clearly, many CPU cycles are wasted just for transferring a byte. A second option is to use a new timer to activate directly the audio input object. In this case, the CPU usage is lower but still considerable. The interrupt service routines have a great impact in the performance of most RISC processors.

The third alternative is to use a direct memory access channel. A DMAC can transfer several words from one memory position to another without CPU intervention. Since the ports of on-chip peripherals are mapped into the memory address space, it is also possible to use a DMAC to transfer from one peripheral to another and from a peripheral to the memory.

In our design, we will use a DMAC to transfer the samples from the microphone into an audio block and from the audio block to the speaker.

A DMAC unit has several registers that control its behaviour. The most important registers are the source address, the target address, the transfer count and several flags. The flags indicate, among other things, if the source or the target addresses should be incremented or not after each transfer or if the transfer unit is a word or a byte. There is also the possibility to do the transfers as fast as possible or to synchronise it with the activity of a timer.

To record the sound, we program the DMAC with the address of the A/D converter as source address. The target address is pointing to an internal buffer with auto increment of the target address after each transfer. The transfer unit is a byte, the size of the samples. We are using a timer, programmed to generate an interrupt 6000 times per second, to initiate each transfer. The DMAC unit starts each transfer when the timer requests the interrupt to the CPU. The transfer will occur even if the CPU has that

interrupt masked and it will never acknowledge it. Actually, we want to have that interrupt masked, so the timer does not disturb the CPU.

After the samples have been recorder into the buffer, the DMAC units generates and interrupt request. The Audio Input attends it and then compresses and stores the input buffer into an audio block.

Figure 7.1 shows the sequence of messages produced when a Message wants to record an audio block.

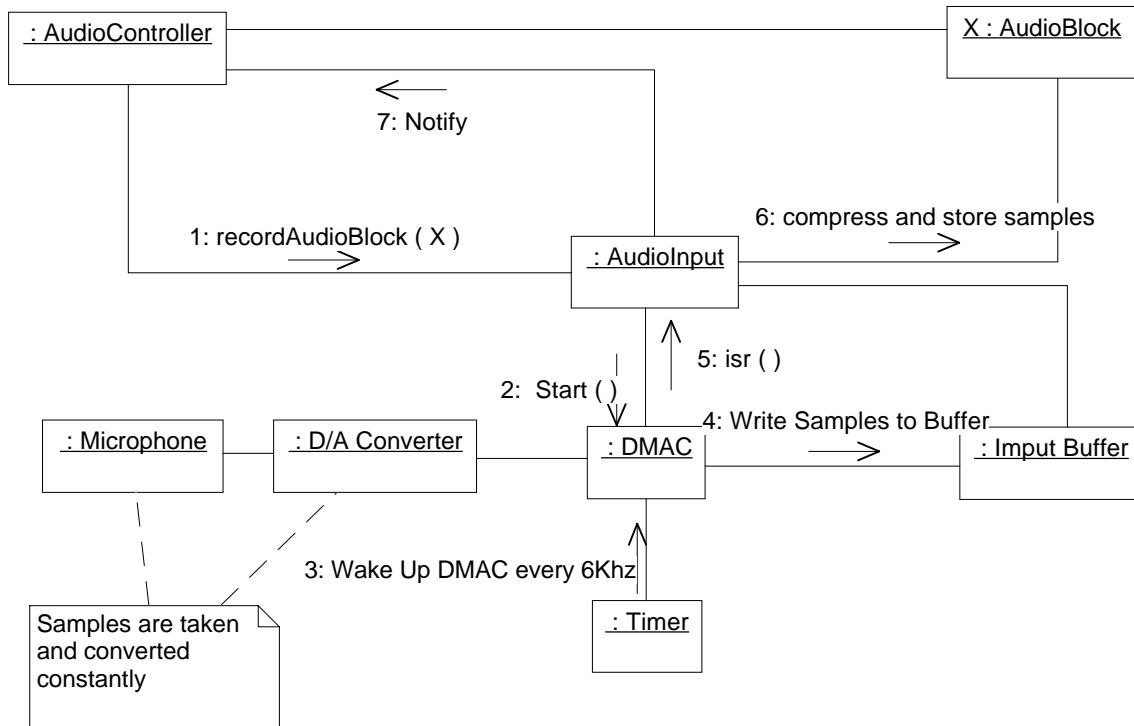

**Figure 7.1: Recording an Audio block**

This sequence is repeated for each audio block of a sound message. Another design issue is the size of the audio blocks. If the blocks are too small, the CPU will expend a lot sending messages between the objects and synchronising its activity with th DMAC. All the messages are composed by an integer number of audio blocks. Th length in seconds and the size in bytes of a message are a multiple of the length and size of the audio blocks. If the blocks are too big then memory is wasted and the system looses responsiveness.

The same mechanism can be used to play back the sound. First, the Audio Output expands the compressed samples from the audio block into a buffer. Then, the DMAC is programmed to transfer the samples into the port of the D/A converter.

This mechanism is only acceptable if the processor can compress and expand th samples really fast. If not, the user will be able to hear a glitch between the reproduction of two audio blocks. This problem can be solved not only by optimising the transfer of a single audio block but also by studding the transfer of a stream of audio blocks.

Since the CPU and the DMAC work in parallel, we can process the stream of audio blocks trough a pipeline. Then, while the DMAC transfers the samples of one audio block, the CPU can uncompress the next audio block.

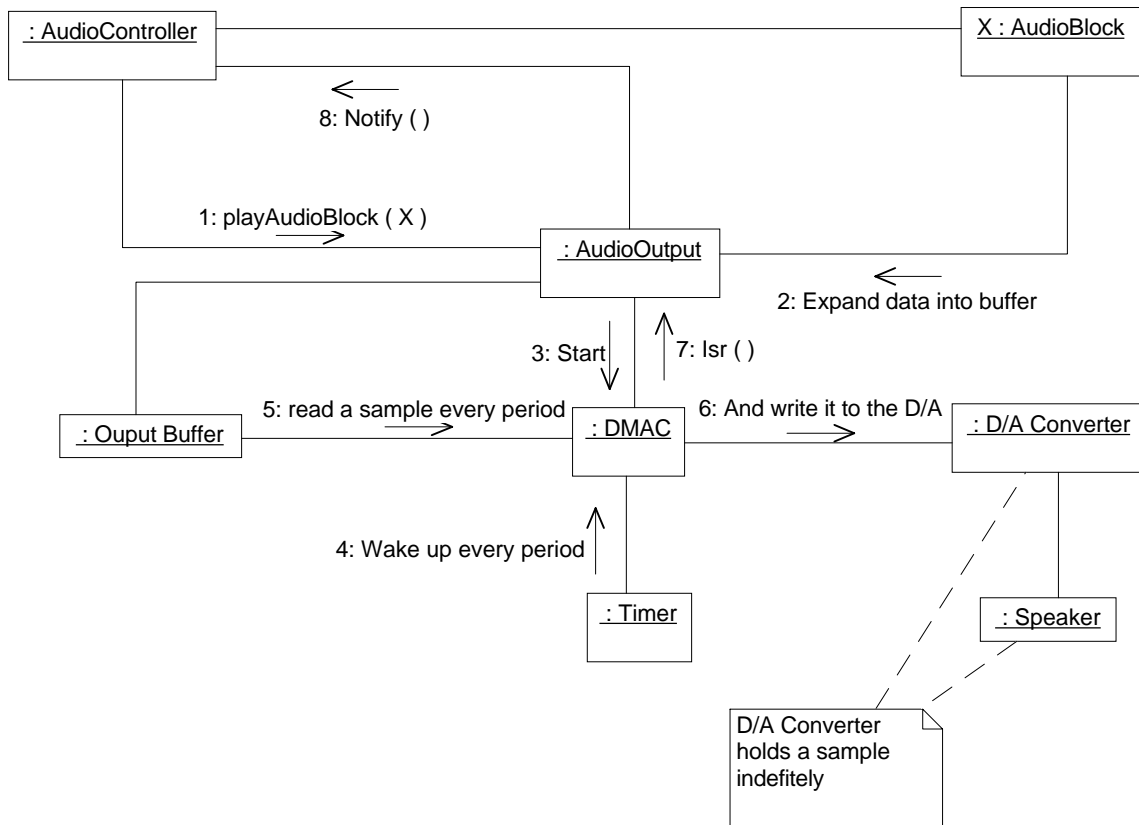

**Figure 7.2: Playing an Audio block**

#### 7.4 Allocating hardware resources

We have to assign the different hardware resources and peripherals to the reactive objects. Since there is a limited number of interrupt vectors, DMA channels, timers, and input/output ports, we have to plan how we are going to using them. Note that is difficult, if not impossible, to multiplex in the time most of this resources.

Object	Resource
Display	Hardware Timer 0
Scheduler	HW Timer 1 IMA1 interrupt vector
Microphone	Analogue input 7 A/D Converter, in auto-convert mode
Speaker	Digital outputs: PB7 toPB0
DMA Channels	HW Timer 2 IMIA2, IMA3 interrupts should be masked
Audio Input	DMA Channel 1 DMAC1 DEI interrupt vector
Audio Output	DMA Channel 2 DMAC2 DEI interrupt vector
Keyboard	Digital output ports: PB4 to PB12 Digital input ports: PC3 to PC0

## **7.5 Memory allocation**

The Message Memory object is the responsible of allocating and freeing the memory space used to store the messages. Since the available memory is quite limited and the system lacks virtual memory, we have to design a mechanism that ensures an optimal use of the system memory. This includes avoiding wasting space by memory fragmentation and object aligning.

When a Message Memory object is created, it allocates an array of Audio Blocks. Each element of the array is marked when used and contains a pointer to the next block into a message stream.

We avoid memory fragmentation by pre-allocating and reusing the memory blocks, instead of creating and destroying them every time a message is recorded or deleted.

Usually, the memory allocation function is only able to allocate memory blocks aligned to a certain size. The size of the Audio Block object is a multiple of the alignment factor of our memory allocation function. That ensures that no single byte is wasted.

## **8 Implementation**

We can consider that the final software product for an embedded system is not program image but a non-volatile memory containing the program.

The linker must statically link all the libraries into the program and allocate all the program symbols into absolute memory addresses. The program must include some code to initialise and check the hardware and rearrange the executable program into the RAM. That includes initialising the processor stack, copying the initialised variables from the read-only memory to the RAM and setting the uninitialised variables to zero. A prototype version of the target usually has a non-volatile memory with a small debugger. The debugger is activated when the system is switched on and it waits for the host computer to download the main program using a communication link, like a serial cable or a network connection. When the program is downloaded, it can be executed and debugged.

When the software has been completely developed and tested, it can be recorded into a non-volatile memory, like a ROM or an EPROM. This memory can be inserted into the target and replace the debugger. When the stand-alone target is switched on then it will execute the application.

### **8.1 Programming language and software tools**

We have chosen the C++ programming language for implementing our system. The decision of choosing a programming language for an embedded system can be affected by the availability of tools for the target architecture. We are using the GNU ToolChain, including the GNU g++, a C++ cross-compiler, the GDB, a cross-platform debugger and the DDD, a graphical front end to GDB.

### **8.2 Building the software**

The current implementation of the software has 3500 lines of C++ code and 2000 lines of legacy C code. The software is built in the host computer by the cross-compiler and it can be downloaded into the prototype or recorded into a ROM or EPROM.

The code uses 40Kb of ROM and 10Kb of RAM plus the storage space for the messages.

### **8.3 Building the hardware**

We have also implemented a prototype version of the hardware of the digital sound recorder. The web page at [SR] contains information about the hardware architecture of the sound recorder. The hardware includes some analogue components, like the amplifier for the speaker or the microphone low-pass filter. The description of these components is beyond the scope of this document. However, they play a big role in the quality of the sound and therefore the user's appreciation of the system.

## **9 Conclusions: Designing in UML**

Along this document we have identified, enumerated, analysed, designed and implemented the main elements of the digital sound recorder. We have used UML as a graphical notation for our design.

We would like that our future designs will contain more UML diagrams and less textual descriptions. To achieve this, we need more software patterns for real-time embedded systems. We would like to use textual descriptions just to explain how we tailor certain software patterns to build our design.

We may also want to split our model into several diagrams to make their size more manageable and to show different aspects of the system. E.g., UML class diagrams show a static view of the system while UML sequence diagrams describe the dynamic behaviour of it. However, the UML semantics [BJR2] does not provide a mechanism to ensure that both diagrams are consistent and both are effectively describing the same system.

UML helps the designer to express her ideas, but also helps the programmer to understand them. Nevertheless, there is no way to enforce a design. There is also a semantic gap from a UML diagram and its implementation. There is not a systematic approach for converting UML diagrams into a complete implementation and it is not possible to check when an implementation follows a UML design.

Figure 9.1 shows the elements forming an object-oriented design of an embedded system. The UML notation is not restricted to describe software systems and it can also be used to describe how to build software systems. Figure 9.1 is an UML class diagram and the design presented in this document an instantiation of it.

### **Acknowledgements**

We would like to thank Marat Vagapov for building the hardware of the digital sound recorder.



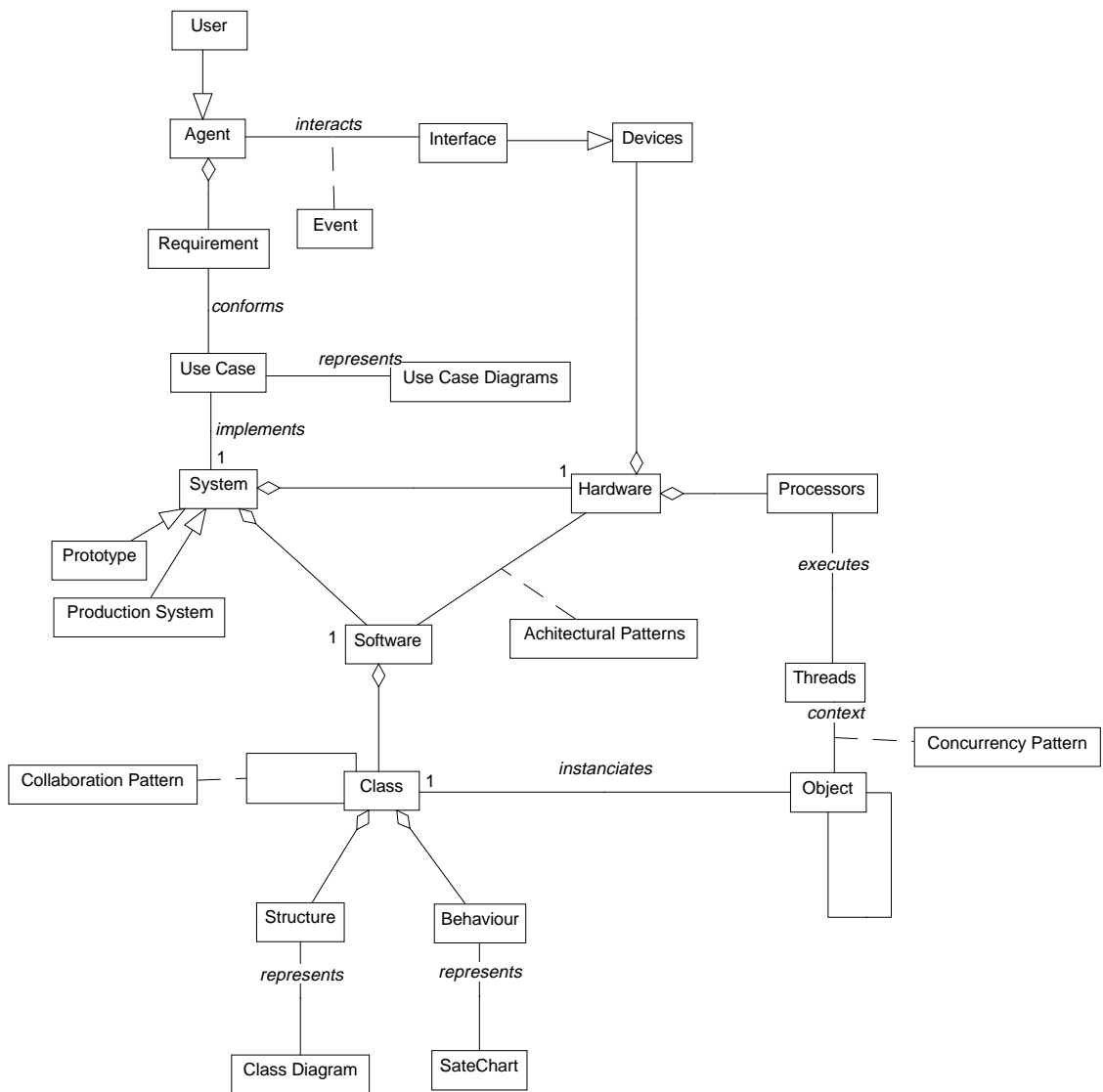

**Figure 9.1: Embedded systems design class diagram**

## Appendix A. Pattern: Reactive Subject

### Problem

A reactive real-time object wants to communicate an event to an interactive non real-time object.

### Context

We are mixing both interactive and reactive objects in the same program and an interactive object needs the most updated state information from a reactive object. Reactive objects usually implement the core of an embedded system. Interactive objects can implement the user interface, system monitoring or data logging tasks.

### Forces

- Embedded real-time systems must complete some tasks within strict deadlines. Interactive systems do not have these restrictions. They usually are easier to design and implement.
- The reactive part can not do any assumption about the response time of the interactive part
- In some applications the interactive part needs to process the full sequence of events sent by the reactive part, but in other cases the interactive part just needs the last produced event, that carries the most updated information.

### Solution

The Reactive Object posts the events to an Event Proxy object. The Event Proxy stores the presence of the event plus a pointer (a reference) to an object. This operation must be done without blocking the Reactive Object.

The Interactive Object periodically polls the Event Proxy to check the presence of a given event by using the checkEvent method of the Event Proxy. If the event is present then the Event Proxy returns the stored pointer to the Interactive Object. If the event is not present then the Event Proxy returns a NIL pointer. The Interactive Object uses the returned pointer to query the state information. In this step, the Interactive Object can be blocked when trying to get the state information. The Event Proxy provides a checkClearEvent method that checks for an event and erases it from the event table if present.

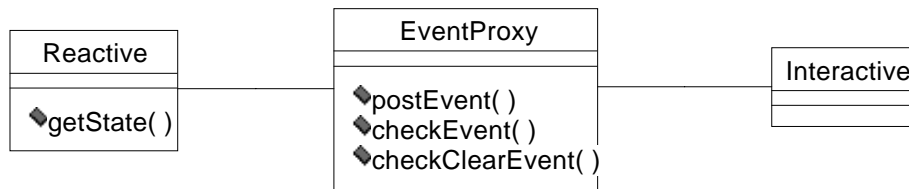

Figure A.1: Event Proxy class diagram

### Rationale

By using extensively this pattern in a system, we are decoupling the reactive, control oriented part of the software to the interactive, and user oriented part. These reports several benefits to our design:

First, the objects do not know the address or even the existence of their partners. It can be possible for a reactive object to post an event that points to a third reactive object that contains the state information.

Second, the objects do not share an execution thread neither need to block or interfere in each other execution. It is possible to implement the Event Proxy in a way that it is not necessary to use any mutual exclusion mechanism and the same time preventing race conditions. This requires the system to be able to write or read a pointer to an object variable atomically. The simplest way to implement it is by storing the event table in an array of pointers to objects indexed by the event type.

### ***Examples***

The collaboration of the Alarm Clock object and the Time View object described above is an example of the Reactive Subject pattern.

## Bibliography

- [AKZ96] M. Awad, J. Kuusela, J. Ziegler, Octopus: Object-Oriented Technology for Real-Time Systems, Prentice Hall 1996.
- [BJR1] G. Booch, I. Jacobson, J. Rumbaugh, editor. UML Notation Guide (Version 1.1). Rational Corporation, Santa Clara, 1997.
- [BJR2] G. Booch, I. Jacobson, J. Rumbaugh, editor. UML Semantics (Version 1.1). Rational Corporation, Santa Clara, 1997.
- [CY90] P. Coad, E. Yourdon. Object-Oriented Analysis. Yourdon Press, Prentice Hall, 1990.
- [Dou98] B. P. Douglass, Real-time UML: developing efficient objects for embedded system, Addison Wesley 1998.
- [GHJV95] E. Gamma, R. Helm, R. Johnson, j. Vlissides, Design Patterns, Addison-Wesley 1995.
- [Gog98] M. Gogolla, UML for the Impatient, University of Bremen, FB3, Computer Science Department.
- [HEVB] Hitachi Ltd., Low-Cost Evaluation Board US7032EVB1 User Manual.
- [HLCD] Hitachi Ltd., Low-Cost Evaluation Board for liquid crystal displays LCMEVB-001 User Manual.
- [HSH1] Hitachi Ltd. SH7000/7600 Series Programming Manual.
- [HSH2] Hitachi Ltd. Hitachi Single-Chip RISC Microcomputer SH7032 and SH7034 Hardware manual.
- [ITU727] International Telecommunication Union. Recommendation G.727 (12/90) - 5-, 4-, 3- and 2-bits sample embedded adaptative differential pulse code modulation (ADPCM) 1990.
- [MO92] J. Martin, J.J. Odell. Object-Oriented Analysis and Design. Prentice Hall 1995.
- [SR] I. Porres Paltor, Hardware Overview of the Digital Sound Recorder. <http://www.abo.fi/~iporres/sr.html>
- [SS95] Ed. Seidewitz, M. Stark, Reliable Object-Oriented Software, Sigs Books 1995.

Turku Centre for Computer Science  
Lemminkäisenkatu 14  
FIN-20520 Turku  
Finland

<http://www.tucs.abo.fi/>



University of Turku  
• Department of Mathematical Sciences



Åbo Akademi University  
• Department of Computer Science  
• Institute for Advanced Management Systems Research



Turku School of Economics and Business Administration  
• Institute of Information Systems Science